

Qty (6)  M10 Lock Washer

Qty (2)  M10-1.50 x 20mm Lg. HHCS

Qty (4)  M10-1.50 x 50mm Lg. SHCS

some hardware will remain after installation; discard.

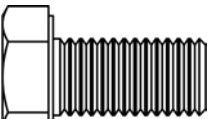
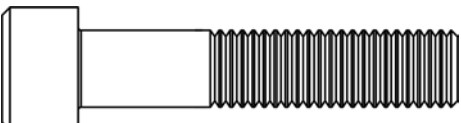
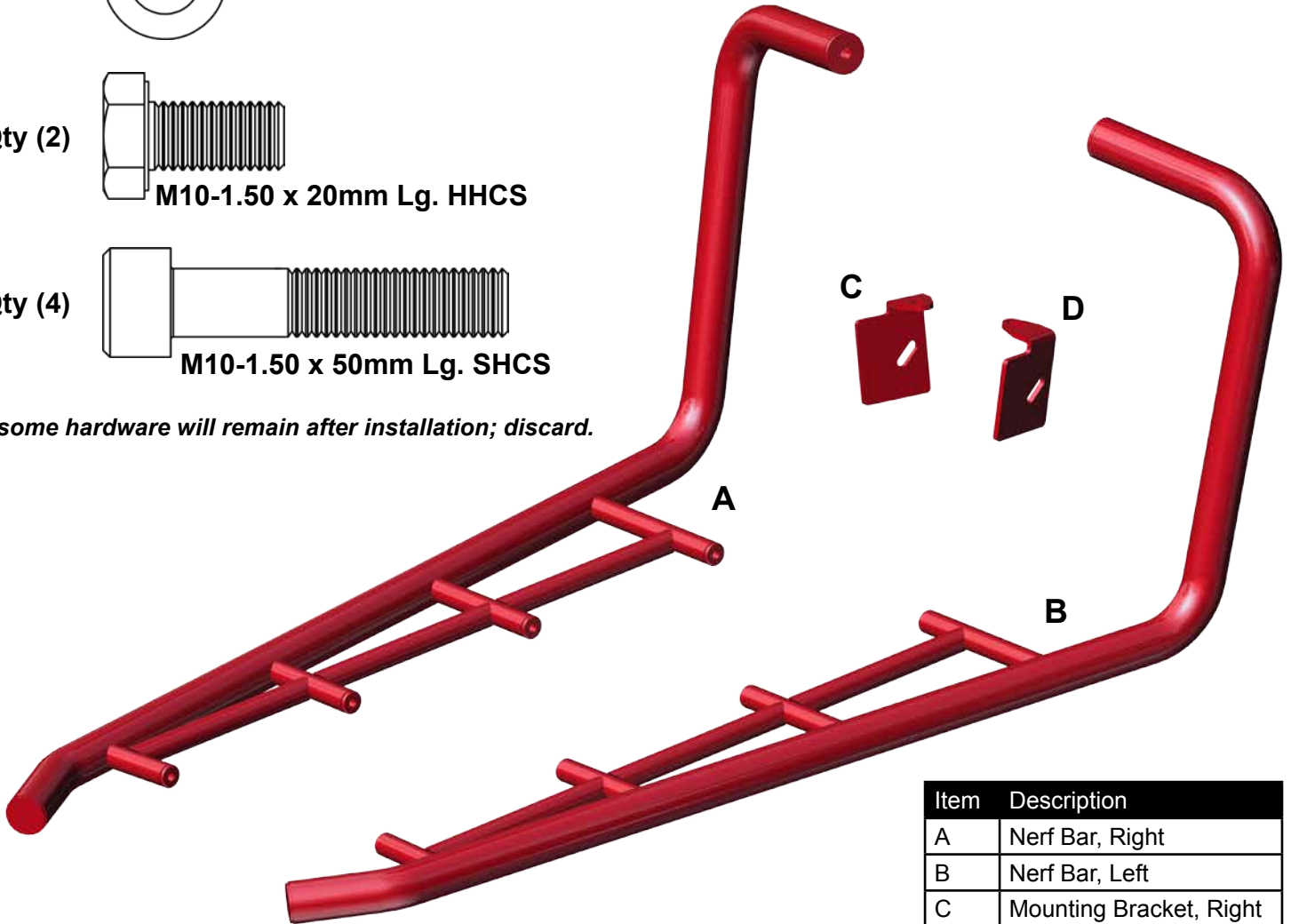

Item	Description
A	Nerf Bar, Right
B	Nerf Bar, Left
C	Mounting Bracket, Right
D	Mounting Bracket, Left

Read instructions and view illustrations before beginning.

Need help with your installation?

 sales@superatv.com
 www.superatv.com

 1-812-574-7777
  8:00am - 9:00pm EST M-Th
8:00am - 7:00pm EST Friday
9:00am - 2:00pm EST Saturday

Thank You
For Choosing
SUPERATV.COM[®]

Liability Statement
SuperATV's[®] products are designed to best fit user's ATV/UTV under stock conditions. Adding, modifying, or fabricating any factory or aftermarket parts will void any warranty provided by SuperATV[®] and is not recommended. SuperATV's[®] products could interfere with other aftermarket accessories. If user has aftermarket products on machine, contact SuperATV[®] to verify that they will work together.

Although SuperATV[®] has thousands of satisfied customers, user should be aware that installing lift kits, long travel, or suspension kits, tires, etc. will change the ride of machine and may increase maintenance and part wear. Operating any off-road machine while, or after, consuming alcohol and/or drugs increases risk of bodily harm or death. No warranty or representation is made as to this product's ability to protect user from severe injury or death. SuperATV[®] urges operators and occupants to wear a helmet and appropriate riding gear at all times.

By purchasing and installing SuperATV[®] products, user agrees that should damages occur, SuperATV[®] will not be held responsible for loss of time, use, labor fees, replacement parts, or freight charges. SuperATV[®], nor any 3rd party, will not be held responsible for any direct, indirect, incidental, special, or consequential damages that result from any product purchased from SuperATV[®]. The total liability of seller to user for all damages, losses, and causes of action, if any, shall not exceed the total purchase price paid for the product that gave rise to the claim.

SuperATV[®] will warranty only parts provided by SuperATV[®]. Any damage or problems with OEM housings, bearings, seals, or other manufacturers' products will not be covered by SuperATV[®]. SuperATV[®] parts and products are not warranted if item was not installed properly, misused, or modified.

Do not tighten hardware completely unless noted. Keep all components removed from machine.

1. Remove Roll Cage Mounting Hardware. See Fig. 1.
 - Install Mounting Bracket, Right (C) with stock hardware from Step 1. See Fig. 1.
2. Install Nerf Bar, Right (A) to Frame with M10-1.50 x 50mm Lg. SHCS and M10 Lock Washers. See Fig. 2.
3. Secure Nerf Bar, Right (A) to Mounting Bracket, Right (C) with M10-1.50 x 20mm Lg HHCS and M10 Lock Washer. See Fig. 3.
4. Repeat steps for opposite side.
5. Align to machine and tighten all hardware securely.

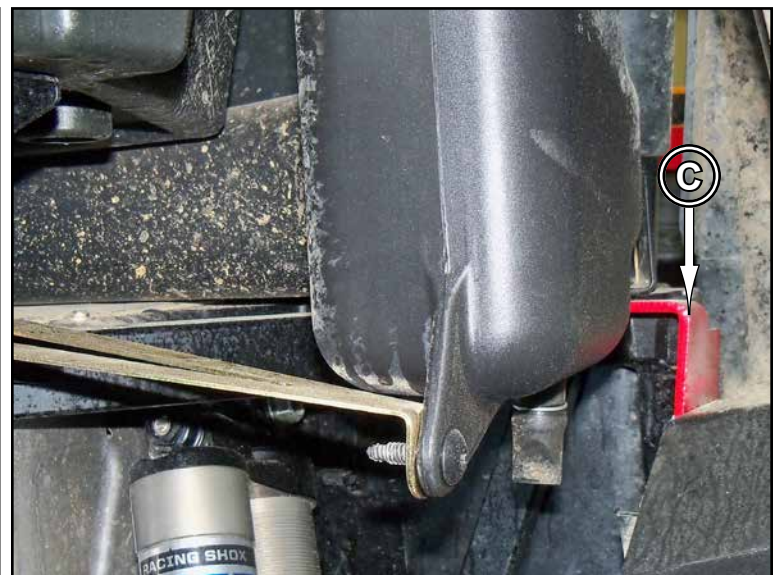
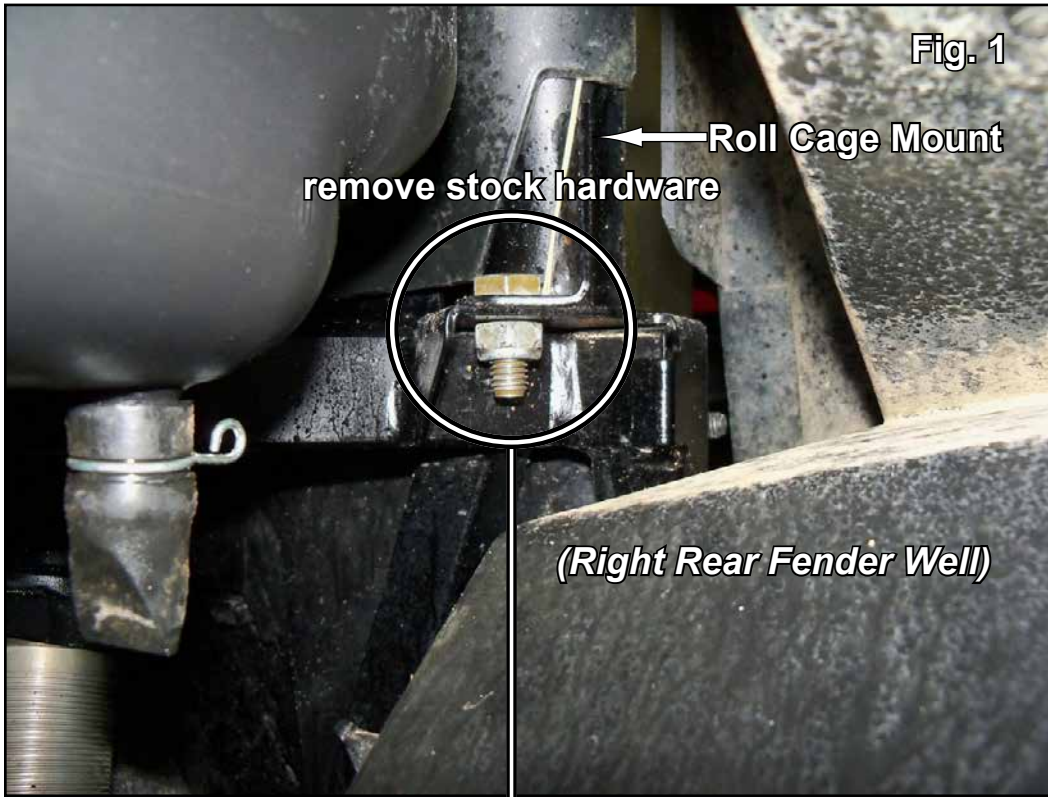

(illustrations continue on following pages)

Fig. 2

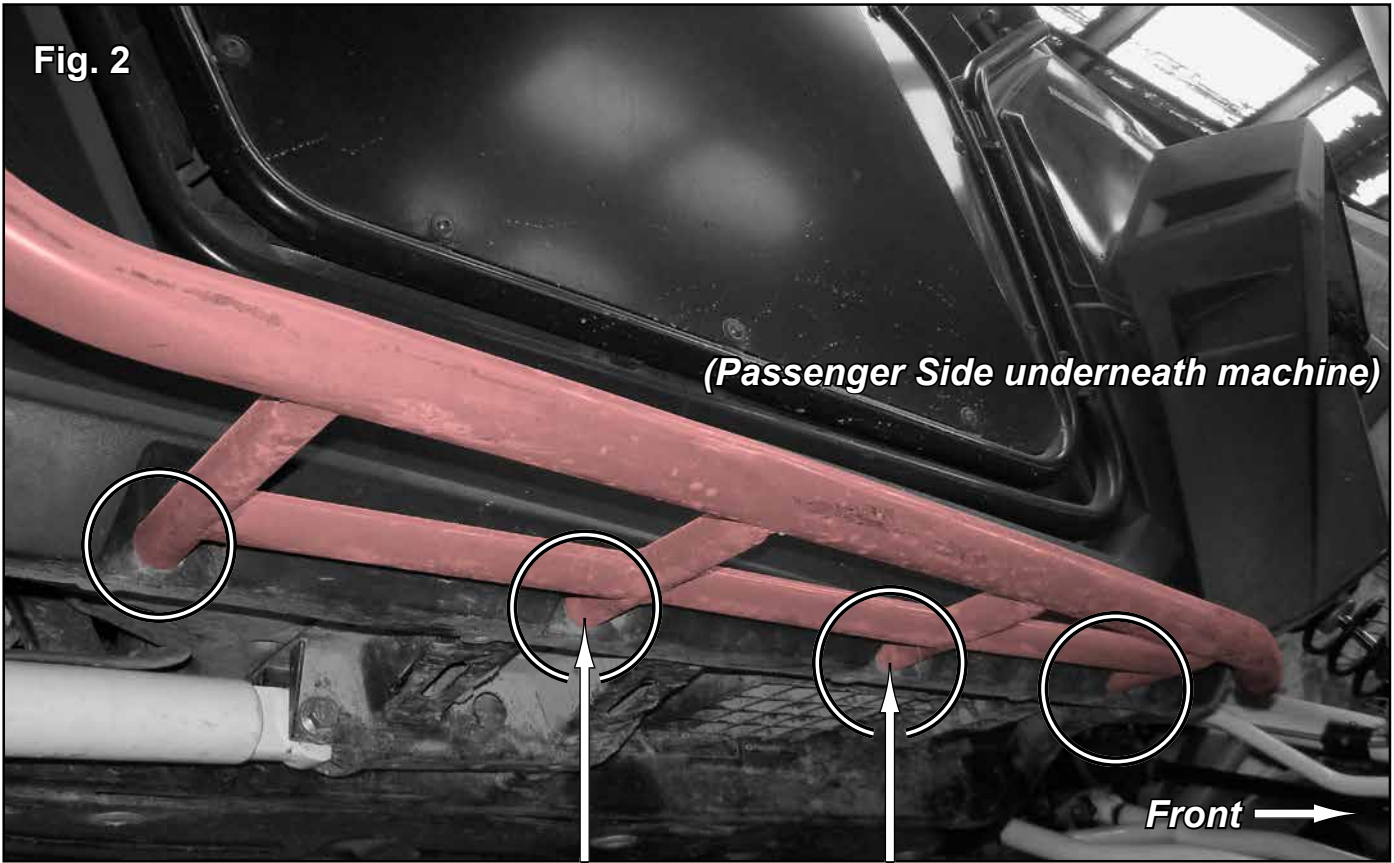

Holes in Frame will need enlarged to accomodate new hardware.

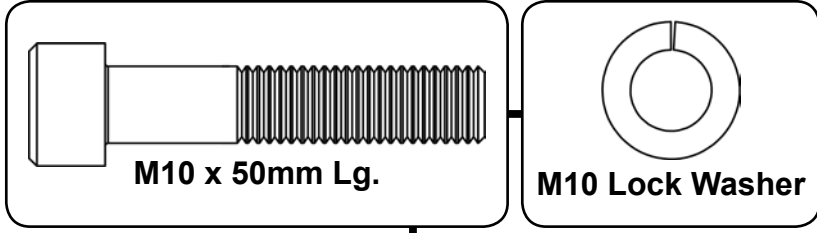

Qty (2) each

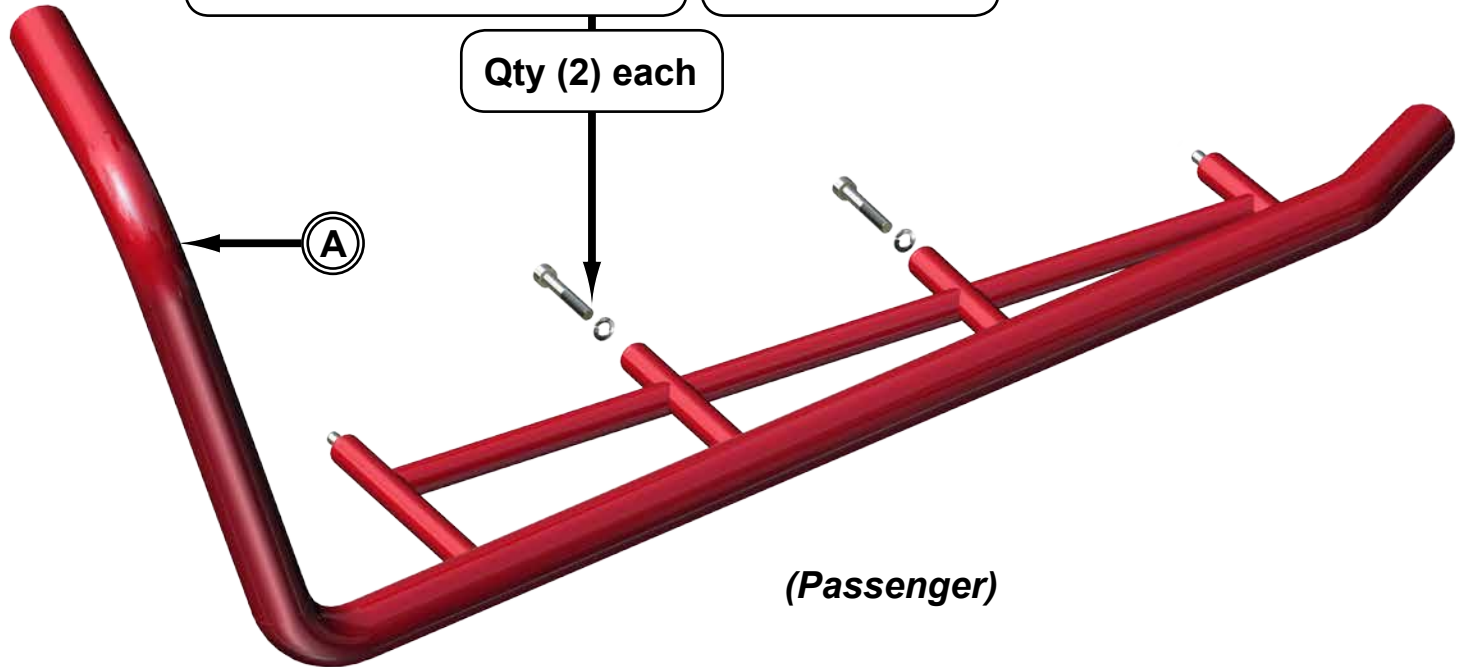

Fig. 3

